



DISCHARGE SYSTEMS

ΣΥΣΤΗΜΑΤΑ
ΑΠΟΧΕΤΕΥΣΗΣ ΛΥΜΑΤΩΝ
& ΟΜΒΡΙΩΝ ΥΔΑΤΩΝ

ΣΩΛΗΝΕΣ & ΕΞΑΡΤΗΜΑΤΑ

Lordos
PLASTICS

Όπου κοιτάξεις!

Εταιρικό Προφίλ	04
Περιγραφή Συστήματος	04
Σωλήνες UPVC	07
Εξαρτήματα UPVC	14
Πιστοποιητικά	25

ΠΕΡΙΕΧΟΜΕΝΑ

ΕΤΑΙΡΙΚΟ ΠΡΟΦΙΛ

Η εταιρεία Lordos United Plastics Public Ltd είναι ο κορυφαίος κατασκευαστής και προμηθευτής ολοκληρωμένων λύσεων συστημάτων αποχέτευσης λυμάτων στην Κύπρο.

Η εταιρεία λειτουργεί κάτω από πιστοποιημένο σύστημα διαχείρισης ποιότητας, σύμφωνα με το πρότυπο CYS EN ISO 9001: 2015 και εφαρμόζει πιστοποιημένο σύστημα περιβαλλοντικής διαχείρισης σύμφωνα με το πρότυπο CYS EN ISO 14001: 2015

LORDOS UPVC SOIL WASTE AND DRAINAGE PIPES SYSTEMS

Οι σωλήνες και τα εξαρτήματα του συστήματος έχουν παραχθεί σύμφωνα με το πρότυπο EN1329

Αυτοί οι σωλήνες και τα εξαρτήματα χρησιμοποιούνται για τη μεταφορά και απόρριψη οικιακών λυμάτων. Επίσης σε αγωγούς όμβριων υδάτων βροχής εντός του κτιρίου.

Οι σωλήνες με την ένδειξη «B» χρησιμοποιούνται μέσα στα κτίρια
Οι σωλήνες που φέρουν την ένδειξη «BD» χρησιμοποιούνται και μέσα στα κτήρια και θαμμένοι στο έδαφος εντός της κτηριακής κατασκευής.

Εφαρμογές σωλήνων και εξαρτημάτων UPVC που παράγονται σύμφωνα με το BS 4514

Αυτό το πρότυπο καλύπτει μόνο το μέγεθος 3"/82x3.0 mm
Οι εφαρμογές είναι ίδιες με τις παραπάνω προδιαγραφές EN 1329



Εφαρμογές σωλήνων και εξαρτημάτων UPVC που παράγονται σύμφωνα με το EN 12200

Οι σωλήνες και τα εξαρτήματα προορίζονται για την μεταφορά και απόρριψη ομβρίων υδάτων.

Χαρακτηριστικά

- Μεγάλη γκάμα σωλήνων και εξαρτημάτων που προσφέρουν ολοκληρωμένα συστήματα και λύσεις
- Υψηλή αντοχή σε χημικά και δεν οξειδώνονται.

Σύστημα σύνδεσης

- Οι σωλήνες συνδέονται μεταξύ τους ή με εξαρτήματα με γόμμα στην περίπτωση ποτηριού ή με σταγανοποιητικό δακτυλίου στην περίπτωση μούφας

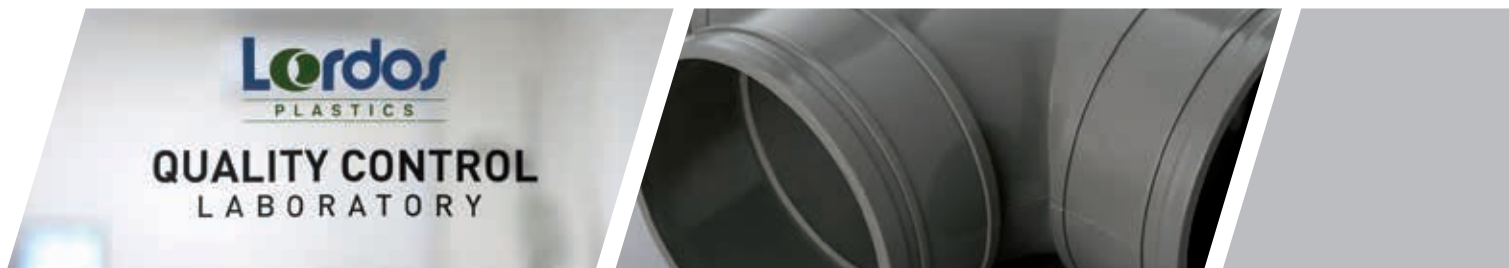

UPVC PIPES





Σωλήνες UPVC



ΣΩΛΗΝΑΣ UPVC CYS EN 1329 / UPVC PIPES CYS EN 1329



CYS EN 1329





ΚΩΔΙΚΟΣ	ΠΕΡΙΟΧΗ ΕΦΑΡΜΟΓΗΣ				ΤΥΠΟΣ		BARCODE
		ΔΙΑΜΕΤΡΟΣ	ΠΑΧΟΣ	ΜΗΚΟΣ		ΣΥΣΚΕΥΑΣΙΑ	
		mm	mm	m		pcs	
2111043401	B	43	3.0	4	P	5	5290119073834
2111043601	B	43	3.0	6	P	5	5290119073841
2111056401	B	56	3.0	4	P	5	5290119073858
2111056601	B	56	3.0	6	P	5	5290119073865
2111110401	BD	110	3.2	4	P	5	5290119052891
2111110403	BD	110	3.2	4	S	5	-
2111110601	B	110	3.2	6	P	5	5290119052907
2111160401	B	160	3.2	4	P	5	5290119052914
2111160601	BD	160	3.2	6	P	5	5290119052921

ΑΠΟΧΕΤΕΥΣΕΩΝ

ΣΩΛΗΝΑΣ UPVC BS 4514 / UPVC PIPES BS 4514



BS 4514





ΚΩΔΙΚΟΣ	ΠΕΡΙΟΧΗ ΕΦΑΡΜΟΓΗΣ				ΤΥΠΟΣ		BARCODE
		ΔΙΑΜΕΤΡΟΣ	ΠΑΧΟΣ	ΜΗΚΟΣ		ΣΥΣΚΕΥΑΣΙΑ	
		mm	mm	m		pcs	
2112082401	BD	82	3.0	4	P	1	5290119052877
2112082601	BD	82	3.0	6	P	1	5290119052884

ΑΠΟΧΕΤΕΥΣΕΩΝ

ΣΩΛΗΝΑΣ UPVC CYS EN 12200 / UPVC PIPES CYS EN 12200



EN 12200

ΚΩΔΙΚΟΣ				ΤΥΠΟΣ		BARCODE
	ΔΙΑΜΕΤΡΟΣ	ΠΑΧΟΣ	ΜΗΚΟΣ		ΣΥΣΚΕΥΑΣΙΑ	
	mm	mm	m		pcs	
2131050401	50	1.5-1.8	4	S/C	5	5290119051320
2131050601	50	1.5-1.8	6	S/C	5	5290119051313
2131056401*	56	1.5-1.8	4	S/C	5	5290119051320
2131056601*	56	1.5-1.8	6	S/C	5	5290119051337
2131063401	63	1.5-1.8	4	S/C	5	5290119051344
2131063601	63	1.5-1.8	6	S/C	5	5290119051351
2131075401	75	1.5-1.8	4	S/C	5	5290119051368
2131075601	75	1.5-1.8	6	S/C	5	5290119051375

* εκτός προτύπου

ΥΔΡΟΡΟΩΝ

ΣΩΛΗΝΑΣ UPVC DIN 8062 / UPVC PIPES DIN 8062



DIN 8062

SDR 51
EN 1401
DIN 8062

ΚΩΔΙΚΟΣ	ΔΙΑΜΕΤΡΟΣ mm	ΠΑΧΟΣ mm	ΜΗΚΟΣ m	ΤΥΠΟΣ	ΣΥΣΚΕΥΑΣΙΑ pcs	BARCODE
2131110401	110	2.2	4	S/C	20	5290119051405
2131110601	110	2.2	6	S/C	20	5290119051412
2131125401	125	2.5	4	S/C	20	5290119051429
2131125601	125	2.5	6	S/C	20	5290119051436
2131180601	180	3.6	6	S/C	20	5290119051474
2131160602	160	3.2	6	S/C	20	5290119051467
2131200601	200	3.9	6	S/C	20	5290119051481
2131250601	250	4.9	6	S/C	20	5290119051498
2131315601	315	6.2	6	S/C	20	5290119051504
2131400601	400	7.9	6	S/C	20	5290119051511

ΥΔΡΟΡΟΩΝ

ΔΙΑΦΟΡΟΙ ΣΩΛΗΝΕΣ UPVC / UPVC VARIOUS PIPES



ΚΩΔΙΚΟΣ	ΔΙΑΜΕΤΡΟΣ mm	ΠΑΧΟΣ mm	ΜΗΚΟΣ m	ΤΥΠΟΣ	ΣΥΣΚΕΥΑΣΙΑ pcs	BARCODE
2131100401	100	2.1	4	S/C	20	5290119051382
2131100601	100	2.1	6	S/C	20	5290119051399
2131160401	160	2.9	4	S/C	20	5290119051443
2131160601	160	2.9	6	S/C	20	5290119051450

ΣΩΛΗΝΑΣ UPVC ΑΠΟΣΤΡΑΓΓΙΣΗΣ DIN 8062 / UPVC DRAINAGE PIPES DIN 8062



DIN 8062

ΚΩΔΙΚΟΣ	ΔΙΑΜΕΤΡΟΣ mm	ΠΑΧΟΣ mm	ΜΗΚΟΣ m	ΤΥΠΟΣ	ΣΥΣΚΕΥΑΣΙΑ pcs
2137110601	110	2.2	6	S/C	1
2137160601*	160	2.9	6	S/C	1
2137160602	160	3.2	6	S/C	1
2137200601	200	3.9	6	S/C	1
2137250601	250	4.9	6	S/C	1
2137315601	315	6.2	6	S/C	1
2137125601	125	2.5	6	S/C	1

Οι σωλήνες ελέγχονται σύμφωνα με τα πρότυπα DIN 8061/8062
The pipes are tested according to DIN 8061/8062 standards

* εκτός προτύπου

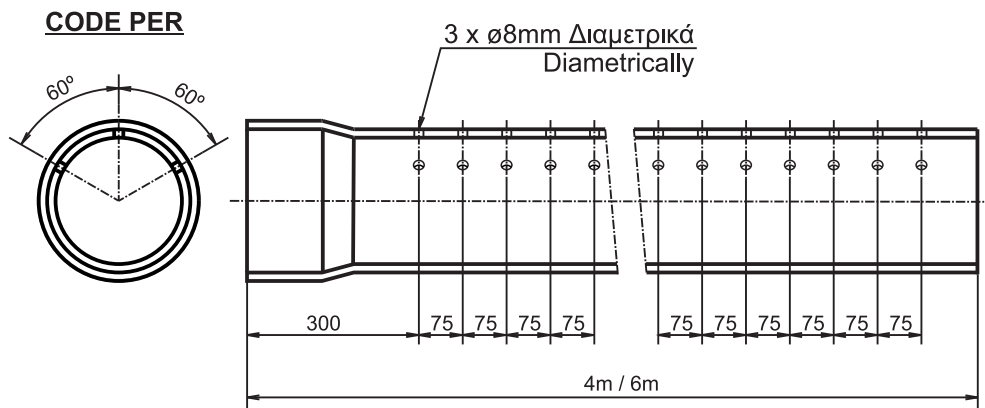

Επιπλέον χρέωση για τρύπημα €1,03 ανά σωλήνα.
Extra charge for perforation €1,03 per pipe.

PERFORATION

ΣΩΛΗΝΑΣ UPVC ΔΙΑΤΡΗΣΕΩΝ DIN 8062 / UPVC WELL CASING PIPES DIN 8062



DIN 8062

ΚΩΔΙΚΟΣ	ΔΙΑΜΕΤΡΟΣ mm	ΠΑΧΟΣ mm	ΜΗΚΟΣ m	ΤΥΠΟΣ	ΣΥΣΚΕΥΑΣΙΑ pcs	BARCODE
2138160601	160	3.2	6	S/C	1	5290119070178
2138180601	180	3.6	6	S/C	1	5290119070185
2139160604	160	3.2	6	S/C	1	5290119070215
2139180602	180	3.6	6	S/C	1	5290119070222

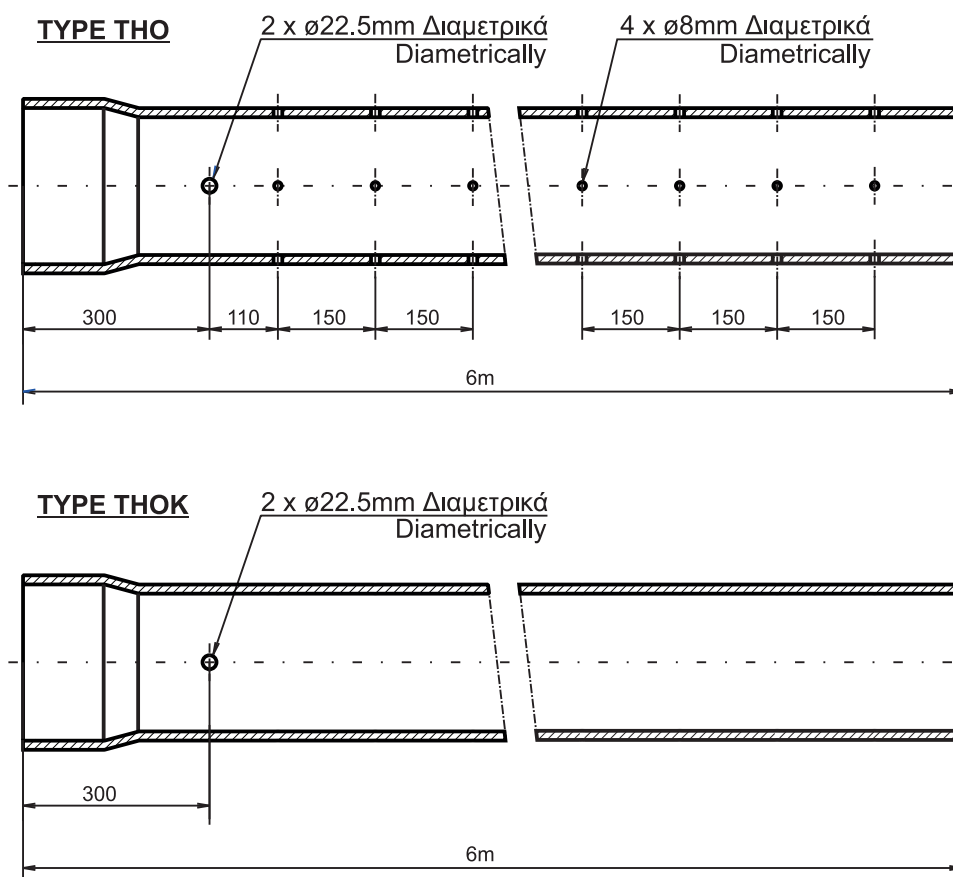

Οι σωλήνες ελέγχονται σύμφωνα με τα πρότυπα DIN 8061/8062
The pipes are tested according to DIN 8061/8062 standards



ΔΙΑΤΡΗΣΕΩΝ

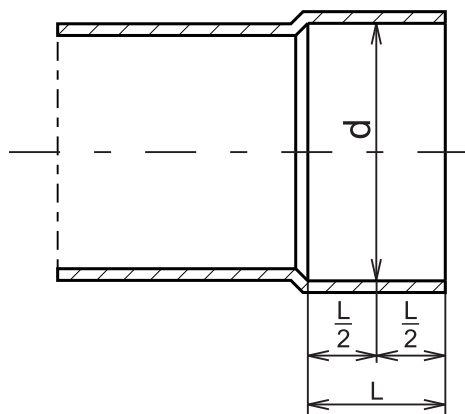

ΔΙΑΣΤΑΣΕΙΣ ΠΟΤΗΡΙΟΥ / DIMENSIONS OF SOCKETS FOR SOLVENT CEMENTING

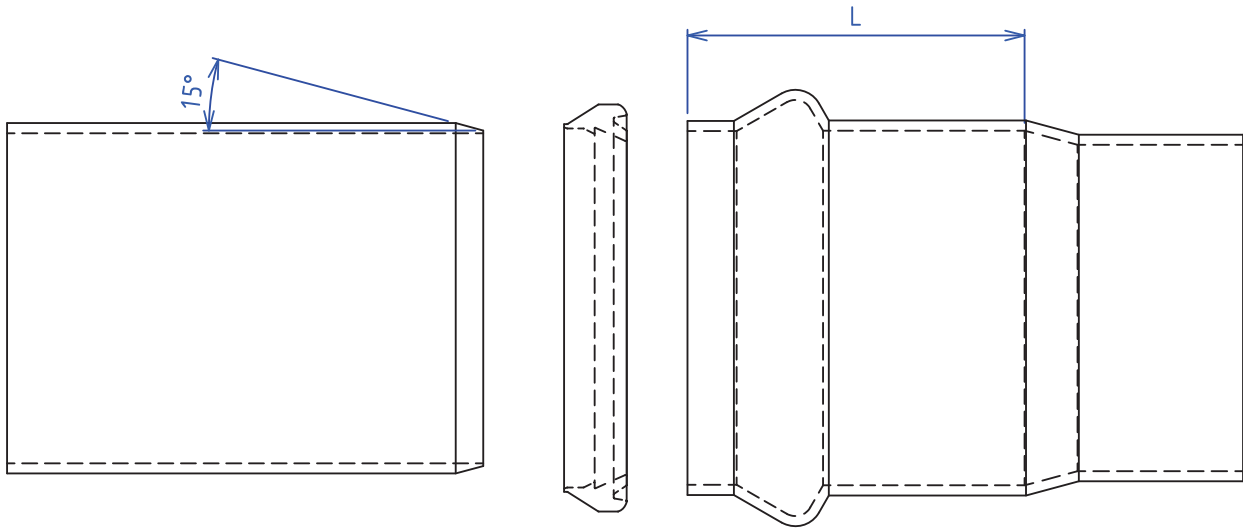

 ΟΝΟΜΑΣΤΙΚΗ ΔΙΑΜΕΤΡΟΣ	 ΜΕΣΗ ΟΝΟΜΑΣΤΙΚΗ ΔΙΑΜΕΤΡΟΣ	 ΕΛΑΧΙΣΤΟ ΜΗΚΟΣ	
mm	dmin - mm	dmax - mm	L - mm
12	12.1	12.3	12.0
16	16.1	16.3	14.0
20	20.1	20.3	16.0
25	25.1	25.3	18.5
32	32.1	32.3	22.0
40	40.1	40.3	26.0
50	50.1	50.3	31.0
63	63.1	63.3	37.5
75	75.1	75.3	43.5
90	90.1	90.3	51.0
110	110.1	110.4	61.0
125	125.1	125.4	68.5
140	140.2	140.5	76.0
160	160.2	160.5	86.0
180	180.2	180.6	96.0
200	200.2	200.6	106.0
225	225.3	225.7	118.5
250	250.3	250.8	131.0
315	315.4	316.0	163.5
400	400.4	401.2	206.0

ΔΙΑΣΤΑΣΕΙΣ ΜΟΥΦΑΣ / DIMENSIONS OF SOCKETS FOR SEALING RING JOINTS



 ΟΝΟΜΑΣΤΙΚΗ ΔΙΑΜΕΤΡΟΣ	 ΜΕΣΗ ΟΝΟΜΑΣΤΙΚΗ ΔΙΑΜΕΤΡΟΣ	 ΕΛΑΧΙΣΤΟ ΜΗΚΟΣ
mm	d _{min} - mm	L - mm
50	50.3	86
63	63.4	90
75	75.4	94
90	90.4	97
110	110.5	104
125	125.5	108
140	140.6	112
160	160.6	119
180	180.7	124
200	200.7	129
225	225.8	136
250	250.9	143
280	281.0	152
315	315.4	160



UPVC FITTINGS

Εξαρτήματα UPVC



ΤΑΠΠΟΣ UPVC ΜΕ ΠΑΣΟ / UPVC THREADED END PLUG





ΚΩΔΙΚΟΣ	 ΔΙΑΜΕΤΡΟΣ	ΥΛΙΚΟ	 ΣΥΣΚΕΥΑΣΙΑ	BARCODE
	mm		pcs	
2331030631	63	UPVC	1	5290119059159
2331030751	75	UPVC	1	5290119059166
2331031251	125	UPVC	1	5290119059173
2331032001	200	UPVC	1	5290119064214
2331033151	315	UPVC	1	5290119064238

ΥΔΡΟΡΡΟΩΝ

ΕΝΩΣΗ UPVC / UPVC COUPLER





ΚΩΔΙΚΟΣ	 ΔΙΑΜΕΤΡΟΣ	ΥΛΙΚΟ	 ΣΥΣΚΕΥΑΣΙΑ	BARCODE
	mm		pcs	
2331020501	50	UPVC	1	5290119051993
2331020631	63	UPVC	1	5290119052006
2331020751	75	UPVC	1	5290119052013
2331021001	100	UPVC	1	5290119072509
2331021251	125	UPVC	1	5290119068908
2331022001	200	UPVC	1	5290119068915

ΥΔΡΟΡΡΟΩΝ

ΛΑΙΜΟΣ UPVC 45° / UPVC BEND 45°





ΚΩΔΙΚΟΣ	 ΔΙΑΜΕΤΡΟΣ	ΤΥΠΟΣ	ΥΛΙΚΟ	 ΣΥΣΚΕΥΑΣΙΑ	BARCODE
	mm			pcs	
2331710501	50	FEMALE/FEMALE	UPVC	1	5290119052020
2331710631	63	FEMALE/FEMALE	UPVC	1	5290119052037
2331710751	75	FEMALE/FEMALE	UPVC	1	5290119052044
2331711001	100	FEMALE/FEMALE	UPVC	1	5290119052051
2331711251	125	FEMALE/FEMALE	UPVC	1	5290119052068
2331712001	200	FEMALE/FEMALE	UPVC	1	5290119052075
2331712501	250	FEMALE/FEMALE	UPVC	1	5290119052082
2331713151	315	FEMALE/FEMALE	UPVC	1	5290119064030

ΥΔΡΟΡΡΟΩΝ

ΛΑΙΜΟΣ UPVC 45° ΑΡΣ./ΘΗΛ. / UPVC BEND 45° MALE/FEMALE





ΚΩΔΙΚΟΣ	 ΔΙΑΜΕΤΡΟΣ	ΤΥΠΟΣ	ΥΛΙΚΟ	 ΣΥΣΚΕΥΑΣΙΑ	BARCODE
	mm			pcs	
2331710632	63	MALE/FEMALE	UPVC	1	5290119052099
2331710752	75	MALE/FEMALE	UPVC	1	5290119052105
2331711002	100	MALE/FEMALE	UPVC	1	5290119071311
2331711103	110	MALE/FEMALE	UPVC	1	5290119069806
2331711252	125	MALE/FEMALE	UPVC	1	5290119009116
2331712002	200	MALE/FEMALE	UPVC	1	5290119007624

ΥΔΡΟΠΡΟΩΝ

ΛΑΙΜΟΣ UPVC 87°-92.5° / UPVC BEND 87°-92.5°





ΚΩΔΙΚΟΣ	 ΔΙΑΜΕΤΡΟΣ	°	ΕΙΔΟΣ	ΥΛΙΚΟ	 ΣΥΣΚΕΥΑΣΙΑ	BARCODE
	mm				pcs	
2331010501	50	87°	FEMALE/FEMALE	UPVC	1	5290119051900
2331010631	63	92.5°	FEMALE/FEMALE	UPVC	1	5290119051917
2331010751	75	92.5°	FEMALE/FEMALE	UPVC	1	5290119051924
2331011001	100	87°	FEMALE/FEMALE	UPVC	1	5290119051931
2331011251	125	87°	FEMALE/FEMALE	UPVC	1	5290119051948
2331012001	200	87°	FEMALE/FEMALE	UPVC	1	5290119051955
2331012501	250	87°	FEMALE/FEMALE	UPVC	1	5290119051962
2331013151	315	87°	FEMALE/FEMALE	UPVC	1	5290119064047

ΥΔΡΟΠΡΟΩΝ

ΛΑΙΜΟΣ UPVC 87°-90° ΑΡΣ./ΘΗΛ. / UPVC BEND 87°-90° MALE/FEMALE





ΚΩΔΙΚΟΣ	 ΔΙΑΜΕΤΡΟΣ	°	ΕΙΔΟΣ	ΥΛΙΚΟ	 ΣΥΣΚΕΥΑΣΙΑ	BARCODE
	mm				pcs	
2331000502	50	90°	MALE/FEMALE	UPVC	1	5290119051979
2331000631	63	90°	MALE/FEMALE	UPVC	1	5290119069783
2331000751	75	90°	MALE/FEMALE	UPVC	1	5290119069790
2331011002	100	87°	MALE/FEMALE	UPVC	1	5290119007600
2331001101	110	90°	MALE/FEMALE	UPVC	1	5290119051986
2331001251	125	90°	MALE/FEMALE	UPVC	1	5290119069813
2331001601	160	90°	MALE/FEMALE	UPVC	1	5290119064054
2331012002	200	87°	MALE/FEMALE	UPVC	1	5290119007617

ΥΔΡΟΠΡΟΩΝ

ΔΙΑΚΛΑΔΩΤΗΣ UPVC 45° / UPVC BRANCH 45°





ΚΩΔΙΚΟΣ	 ΔΙΑΜΕΤΡΟΣ	ΕΙΔΟΣ	ΥΛΙΚΟ	 ΣΥΣΚΕΥΑΣΙΑ	BARCODE
	mm			pcs	
2331240501	50	FEMALE/FEMALE	UPVC	1	5290119008249
2331240631	63	FEMALE/FEMALE	UPVC	1	5290119052310
2331240751	75	FEMALE/FEMALE	UPVC	1	5290119052327
2331241251	125	FEMALE/FEMALE	UPVC	1	5290119052334
2331242001	200	FEMALE/FEMALE	UPVC	1	5290119052341
2331242501	250	FEMALE/FEMALE	UPVC	1	5290119052358

ΥΔΡΟΠΡΟΩΝ

ΤΑΦ UPVC 45° / UPVC TEE EQUAL 45°





ΚΩΔΙΚΟΣ	 ΔΙΑΜΕΤΡΟΣ	ΥΛΙΚΟ	 ΣΥΣΚΕΥΑΣΙΑ	BARCODE
	mm		pcs	
2331240631	63	UPVC	1	5290119052310
2331240751	75	UPVC	1	5290119052327

ΥΔΡΟΠΡΟΩΝ

ΤΑΦ UPVC 87°- 92.5° / UPVC TEE EQUAL 87°- 92.5°





ΚΩΔΙΚΟΣ	 ΔΙΑΜΕΤΡΟΣ	°	ΕΙΔΟΣ	ΥΛΙΚΟ	 ΣΥΣΚΕΥΑΣΙΑ	BARCODE
	mm				pcs	
2331050501	50	87°	FEMALE/FEMALE	UPVC	1	5290119052181
2331050631	63	92.5°	FEMALE/FEMALE	UPVC	1	5290119052198
2331050751	75	92.5°	FEMALE/FEMALE	UPVC	1	5290119052204
2331051001	100	87°	FEMALE/FEMALE	UPVC	1	5290119052211
2331051101	110	90°	FEMALE/FEMALE	UPVC	1	5290119052174
2331051251	125	87°	FEMALE/FEMALE	UPVC	1	5290119052228
2331052001	200	87°	FEMALE/FEMALE	UPVC	1	5290119052235
2331052501	250	87°	FEMALE/FEMALE	UPVC	1	5290119052242
2331053151	315	87°	FEMALE/FEMALE	UPVC	1	5290119064115
2331050752	75	92.5°	MALE/FEMALE	UPVC	1	5290119007631

ΥΔΡΟΠΡΟΩΝ

ΜΕΤΑΠΤΩΣΗ UPVC / REDUCER UPVC





ΚΩΔΙΚΟΣ	 ΔΙΑΜΕΤΡΟΣ	ΕΙΔΟΣ	ΥΛΙΚΟ	 ΣΥΣΚΕΥΑΣΙΑ	BARCODE
	mm			pcs	
2331046351	63x50	FEMALE/FEMALE	UPVC	1	-
2331047551	75x50	FEMALE/FEMALE	UPVC	1	5290119052136
2331047561	75x63	FEMALE/FEMALE	UPVC	1	5290119071175
2331041102	110x63	FEMALE/FEMALE	UPVC	1	5290119008577
2331041101	110x75	FEMALE/FEMALE	UPVC	1	5290119052150
2331041251	125x110	FEMALE/FEMALE	UPVC	1	5290119064177
2331041601	160x125	FEMALE/FEMALE	UPVC	1	5290119007143
2331042001	200x160	FEMALE/FEMALE	UPVC	1	5290119052167
2331042501	250x200	FEMALE/FEMALE	UPVC	1	5290119064184
2331043151	315x250	FEMALE/FEMALE	UPVC	1	5290119064191

ΥΔΡΟΠΡΟΩΝ

ΓΡΑΔΕΛΑ ΕΞΑΕΡΙΣΜΟΥ / VENTILATION GRILL ROUND





ΚΩΔΙΚΟΣ	 ΔΙΑΜΕΤΡΟΣ	ΧΡΩΜΑ	ΥΛΙΚΟ	 ΣΥΣΚΕΥΑΣΙΑ	BARCODE
	mm			pcs	
2331360631	63	ΓΚΡΙΖΟ	POLYPROPYLENE	30	5290119052266
2331360751	75	ΓΚΡΙΖΟ	POLYPROPYLENE	20	5290119052273
2331360632	63	ΑΣΠΡΟ	POLYPROPYLENE	30	5290119052297
2331360752	75	ΑΣΠΡΟ	POLYPROPYLENE	20	5290119052303
2331360562	56	ΑΣΠΡΟ	POLYPROPYLENE	40	5290119052280
2331360561	56	ΓΚΡΙΖΟ	POLYPROPYLENE	40	5290119052259

ΥΔΡΟΠΡΟΩΝ

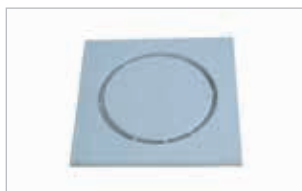
ΓΡΑΔΕΛΑ ΕΞΑΕΡΙΣΜΟΥ / VENTILATION GRILL SQUARE





ΚΩΔΙΚΟΣ	 ΔΙΑΜΕΤΡΟΣ	ΧΡΩΜΑ	ΥΛΙΚΟ	 ΣΥΣΚΕΥΑΣΙΑ	BARCODE
	mm			pcs	
2331361501	150x150x4"	ΑΣΠΡΟ	UPVC	1	5290119064153

ΥΔΡΟΠΡΟΩΝ

ΤΑΠΠΟΣ ΜΕ ΠΑΣΟ UPVC EN 1329 & BS 4514 / UPVC END PLUG ACCESS EN 1329 & BS 4514



EN 1329
BS 4514



ΚΩΔΙΚΟΣ	 ΔΙΑΜΕΤΡΟΣ	ΠΡΟΤΥΠΟ	ΥΛΙΚΟ	 ΣΥΣΚΕΥΑΣΙΑ	BARCODE
	mm			pcs	
2319030431	43	-	UPVC	1	5290119052945
2319030561	56	-	UPVC	15	5290119052938
2312030821	82	BS 4514	UPVC	100	5290119053195
2311031101	110	EN 1329	UPVC	1	5290119053201
2311031601	160	EN 1329	UPVC	1	5290119053218

ΑΠΟΧΕΤΕΥΣΕΩΝ

ΕΝΩΣΗ UPVC EN 1329 & BS 4514 / UPVC COUPLER EN 1329 & BS 4514





EN 1329
BS 4514

ΚΩΔΙΚΟΣ	 ΔΙΑΜΕΤΡΟΣ	ΠΡΟΤΥΠΟ	ΥΛΙΚΟ	 ΣΥΣΚΕΥΑΣΙΑ	BARCODE
	mm			pcs	
2319020431	43	-	UPVC	15	5290119053003
2311020561	56	EN 1329	UPVC	10	5290119052990
2312020821	82	BS 4514	UPVC	1	5290119053270
2311021101	110	EN 1329	UPVC	40	5290119053287
2311021601	160	EN 1329	UPVC	1	5290119053294
2311021602	160	EN 1329	UPVC	1	-

ΑΠΟΧΕΤΕΥΣΕΩΝ

ΕΝΩΣΗ ΝΙΠΤΗΡΑ ΛΑΣΤΙΧΟ UPVC / UPVC COUPLER FOR BASIN





ΚΩΔΙΚΟΣ	 ΔΙΑΜΕΤΡΟΣ	ΥΛΙΚΟ	 ΣΥΣΚΕΥΑΣΙΑ	BARCODE
	mm		pcs	
2319020433	43	NBR	1	5290119053027
2319020561	50	NBR	1	5290119053034
2319020501	56	NBR	1	5290119053010

ΑΠΟΧΕΤΕΥΣΕΩΝ

ΚΑΠΕΛΟ ΕΞΑΕΡΙΣΜΟΥ UPVC / UPVC VENT COWL





ΚΩΔΙΚΟΣ	 ΔΙΑΜΕΤΡΟΣ	ΥΛΙΚΟ	 ΣΥΣΚΕΥΑΣΙΑ	BARCODE
	mm		pcs	
2319260561	56	UPVC	1	5290119053065
2319260821	82	UPVC	1	5290119053331
2319261101	110	UPVC	1	5290119053348

ΑΠΟΧΕΤΕΥΣΕΩΝ

ΕΞΠΑΝΣΙΟΝ UPVC / UPVC EXPANSION UNIT





ΚΩΔΙΚΟΣ	 ΔΙΑΜΕΤΡΟΣ	ΥΛΙΚΟ	 ΣΥΣΚΕΥΑΣΙΑ	BARCODE
	mm		pcs	
2331990821	82	UPVC	1	5290119064245
2331991102	110	UPVC	1	5290119064252

ΑΠΟΧΕΤΕΥΣΕΩΝ

ΛΑΙΜΟΣ UPVC 45°- 92.5° / UPVC BEND 45°- 92.5°



ΚΩΔΙΚΟΣ	 ΔΙΑΜΕΤΡΟΣ	°	ΕΙΔΟΣ	ΠΡΟΤΥΠΟ	ΥΛΙΚΟ	 ΣΥΣΚΕΥΑΣΙΑ	BARCODE
	mm					pcs	
2319710431	43	45°	-	UPVC	UPVC	15	5290119053058
2311710561	56	45°	-	UPVC	UPVC	15	5290119053041
2312710821	82	45°	-	UPVC	UPVC	90	5290119053300
2311711101	110	45°	-	UPVC	UPVC	40	5290119053317
2311711601	160	45°	-	UPVC	UPVC	1	5290119053324
2319010431	43	92.5°	-	UPVC	UPVC	10	5290119052976
2311010561	56	92.5°	-	UPVC	UPVC	160	5290119052969
2312010821	82	92.5°	-	UPVC	UPVC	25	5290119053225
2311011101	110	92.5°	-	UPVC	UPVC	18	5290119053232
2311001601	160	90°	-	UPVC	UPVC	1	5290119053249
2319010561	56	92.5°	-	UPVC	UPVC	1	5290119071076
2311000561	56	90°	SHORT	UPVC	UPVC	140	5290119052983
2312000822	82	90°	SHORT	UPVC	UPVC	1	5290119053256
2311001102	110	90°	SHORT	UPVC	UPVC	24	5290119053263
2319710561	56	45°	MALE/FEMALE	UPVC	UPVC	1	5290119009048
2311011601	160	87°	FEMALE/FEMALE	UPVC	UPVC	1	-
2311711602	160	45°	FEMALE/FEMALE	UPVC	UPVC	1	-

ΑΠΟΧΕΤΕΥΣΕΩΝ

ΜΕΤΑΠΤΩΣΗ UPVC EN 1329 & BS 4514 / UPVC REDUCER EN 1329 & BS 4514



EN 1329
BS 4514

ΚΩΔΙΚΟΣ	ΔΙΑΜΕΤΡΟΣ mm	ΠΡΟΤΥΠΟ	ΥΛΙΚΟ	ΣΥΣΚΕΥΑΣΙΑ pcs	BARCODE
2319045641	56x43	-	UPVC	200	5290119053072
2311048251	82x56	EN 1329	UPVC	10	5290119053362
2311041101	110x56	EN 1329	UPVC	5	5290119053379
2311041103	110x82	EN 1329	UPVC	1	5290119053386
2311041601	160x110	EN 1329	UPVC	1	5290119053393
2311041602	160x110	EN 1329	UPVC	1	-

ΑΠΟΧΕΤΕΥΣΕΩΝ

ΣΤΑΡΤΕΡ ΘΗΛΥΚΟ UPVC / UPVC ADAPTOR THREADED FEMALE



ΚΩΔΙΚΟΣ	ΔΙΑΜΕΤΡΟΣ mm	ΥΛΙΚΟ	ΣΥΣΚΕΥΑΣΙΑ pcs	BARCODE
2319085621	56	UPVC	300	5290119053089
2319085622	56	UPVC	25	5290119053096
2319084321	43	UPVC	150	5290119053102

ΑΠΟΧΕΤΕΥΣΕΩΝ

ΣΤΑΡΤΕΡ ΑΡΣΕΝΙΚΟ UPVC / UPVC ADAPTOR THREADED MALE



ΚΩΔΙΚΟΣ	ΔΙΑΜΕΤΡΟΣ mm	ΥΛΙΚΟ	ΣΥΣΚΕΥΑΣΙΑ pcs	BARCODE
2319085623	56	UPVC	300	5290119053119
2319084322	43	UPVC	150	5290119053126

ΑΠΟΧΕΤΕΥΣΕΩΝ

ΤΑΦ 87°-92.5° UPVC EN 1329 & BS 4514 / UPVC TEE EQUAL 87°-92.5° EN 1329 & BS 4514



EN 1329
BS 4514

ΚΩΔΙΚΟΣ	ΔΙΑΜΕΤΡΟΣ	°	ΠΡΟΤΥΠΟ	ΥΛΙΚΟ	ΣΥΣΚΕΥΑΣΙΑ	BARCODE
	mm				pcs	
2319050431	43x43x43	92.5°	EN 1329	UPVC	180	5290119053140
2311050561	56x56x56	92.5°	EN 1329	UPVC	75	5290119053133
2312050821	82x82x82	92.5°	BS 4514	UPVC	20	5290119053447
2311051101	110x110x110	92.5°	EN 1329	UPVC	12	5290119053454
2311051601	160x160x160	90°	EN 1329	UPVC	1	5290119053461
2311051603	160x160x160	87°	EN 1329	UPVC	1	-

ΑΠΟΧΕΤΕΥΣΕΩΝ

ΤΑΦ ΜΕΤΑΠΤΩΤΙΚΟ 90° UPVC BS EN 1329 & BS 4514 / UPVC TEE REDUCING 90° BS EN 1329 & BS 4514



EN 1329
BS 4514

ΚΩΔΙΚΟΣ	ΔΙΑΜΕΤΡΟΣ	ΠΡΟΤΥΠΟ	ΥΛΙΚΟ	ΣΥΣΚΕΥΑΣΙΑ	BARCODE
	mm			pcs	
2312058251	82x56x82	BS 4514	UPVC	1	5290119053409
2312050822	82	BS 4514	UPVC	10	5290119007402
2312051101	110x56x110	BS 4514	UPVC	1	5290119053416
2312051102	110x82x110	BS 4514	UPVC	1	5290119053423
2311051602	160x110x160	EN 1329	UPVC	1	5290119053430

ΑΠΟΧΕΤΕΥΣΕΩΝ

ΣΤΑΥΡΟΣ 92.5° UPVC EN 1329 & BS 4514 / UPVC CROSS 92.5° EN 1329 & BS 4514



EN 1329
BS 4514

ΚΩΔΙΚΟΣ	ΔΙΑΜΕΤΡΟΣ	ΠΡΟΤΥΠΟ	ΥΛΙΚΟ	ΣΥΣΚΕΥΑΣΙΑ	BARCODE
	mm			pcs	
2319250431	43	-	UPVC	1	5290119075616
2319250561	56	-	UPVC	1	5290119053157
2312250821	82	BS 4514	UPVC	1	5290119053478
2311251101	110	EN 1329	UPVC	1	5290119053485
2311251601	160	EN 1329	UPVC	1	-

ΑΠΟΧΕΤΕΥΣΕΩΝ

ΤΑΦ 45° UPVC EN 1329 & BS 4514 / UPVC BRANCH 45° EN 1329 & BS 4514



EN 1329
BS 4514

ΚΩΔΙΚΟΣ	ΔΙΑΜΕΤΡΟΣ mm	ΠΡΟΤΥΠΟ	ΥΛΙΚΟ	ΣΥΣΚΕΥΑΣΙΑ pcs	BARCODE
2319240431	43	-	UPVC	150	5290119053171
2319240561	56	-	UPVC	75	5290119053164
2312240821	82	BS 4514	UPVC	1	5290119053492
2311241101	110	EN 1329	UPVC	11	5290119053508
2311241102	110	EN 1329	UPVC	1	5290119064160
2311241602	160	EN 1329	UPVC	1	5290119053515
2311241601	160	EN 1329	UPVC	1	-
2311241603	160	EN 1329	UPVC	1	-

ΑΠΟΧΕΤΕΥΣΕΩΝ

ΤΑΦ ΑΡΣ./ΘΗΛ. 92.5° UPVC EN 1329 / UPVC TEE MALE/FEMALE 92.5° EN 1329



EN 1329

ΚΩΔΙΚΟΣ	ΔΙΑΜΕΤΡΟΣ mm	ΠΡΟΤΥΠΟ	ΥΛΙΚΟ	ΣΥΣΚΕΥΑΣΙΑ pcs	BARCODE
2311051102	110	EN 1329	UPVC	12	5290119072363

ΑΠΟΧΕΤΕΥΣΕΩΝ

ΤΑΦ ΚΟΝΤΟ 90° UPVC EN 1329 / UPVC TEE EQUAL SHORT 90° EN 1329



EN 1329
BS 4514

ΚΩΔΙΚΟΣ	ΔΙΑΜΕΤΡΟΣ mm	ΠΡΟΤΥΠΟ	ΥΛΙΚΟ	ΣΥΣΚΕΥΑΣΙΑ pcs	BARCODE
2312050822	82	BS 4514	UPVC	1	5290119007402
2311051103	110	EN 1329	UPVC	1	5290119064078

ΑΠΟΧΕΤΕΥΣΕΩΝ

ΣΥΣΤΗΜΑ ΑΠΟΣΤΡΑΓΓΙΣΗΣ DRAINAGE CHANNEL KIT 3M 100X100MM



ΚΩΔΙΚΟΣ



ΔΙΑΣΤΑΣΕΙΣ

mm

2331991003

100x100



ΜΗΚΟΣ

m

3



ΣΥΣΚΕΥΑΣΙΑ

pcs

3

BARCODE

5290119007488

ΠΑΚΕΤΟ ΕΞΟΠΛΙΣΜΟΥ ΜΕ 3 ΑΓΩΓΟΥΣ + 2 ΠΩΜΑΤΑ ΚΕΦΑΛΗΣ

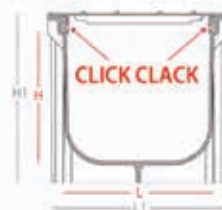

διαστάσεις κιβωτίου	παλέτα	εξαρτήματα			πλήρες πακέτο εξοπλισμού
L x H x P cm	π.	αγωγός PP	σχάρα	πώμα κεφαλής	€
100 x 40 x 12	20	π.3	π.3	π.2	28,35



ΠΙΣΤΟΠΟΙΗΤΙΚΑ / CERTIFICATES



Σημειώσεις

- Η Lordos United Plastics Public Ltd, μέσα στα πλαίσια της πολιτικής της για συνεχή βελτίωση των προϊόντων της και λαμβάνοντας υπόψιν τις τροποποιήσεις που γίνονται στα πρότυπα και τις εξελίξεις στον τομέα των πρώτων υλών, διατηρεί το δικαίωμα να τροποποιήσει μερικά ή όλα τα προϊόντα της που παρουσιάζονται στον κατάλογο αυτό, χωρίς προηγούμενη ειδοποίηση.
- Ο κατάλογος αυτός αποτελεί ιδιοκτησία της Lordos United Plastics Public Ltd, και απαγορεύεται η αντιγραφή, αναπαραγωγή, τροποποίηση, δημοσίευση, ανάρτηση μέρους ή όλου του καταλόγου, χωρίς την προηγούμενη έγγραφη άδεια της Lordos United Plastics Public Ltd, καθώς παρέχεται μόνο για ενημερωτικούς και εκπαιδευτικούς σκοπούς.



ISO 9001



ISO 14001



Sewerage & Drainage Systems

Electrical Systems

Plumbing Systems

Irrigation & Domestic Applications Systems

Construction Profiles

Pressure Pipes

Discharge Systems: Low Noise

Discharge Systems

Lordos
PLASTICS

Όπου κοιτάξεις!

CUSTOMER SERVICE & SUPPORT 77 77 75 57

LORDOS UNITED PLASTICS PUBLIC LTD
ΚΕΝΤΡΙΚΑ ΓΡΑΦΕΙΑ

Οδός Επιμηθέως, Α' Βιομηχ. Περιοχή Λεμεσού, 3056 Λεμεσός, Κύπρος Ταχ. Θυρ. 51358, 3504 Λεμεσός, Κύπρος
Τηλ.: +357 25 885555 Φαξ: +357 25 885588

ΑΠΟΘΗΚΗ ΛΕΥΚΩΣΙΑΣ
Τηλ.: +357 25885555 Φαξ: +357 22 878948

email: lordos@lordosplastics.com
www.lordosplastics.com